



Izerwaren
Order
numbers

- Stainless Steel Heavy Duty Mortise Lock
- For Full Size Doors.
- Minimum Door Thickness 38 mm / 1.5 inch
- Backset 65 mm
- Standard finish: Satin Stainless Steel
- Option: Mirror Polished Stainless Steel

14.31U.208 **Set:** Entry Door Mortise Lock: Levers, escutcheons, strike plate and profile cylinder Mirror Polished Stainless Steel

14.3127 Entry Door Mortise Lock only
Lock case: 97 mm x 164 mm x 16 mm
Backset 65 mm PC= 72 mm
Front plate 235 x 24 mm
For 9x9 mm spindle

14.0031.208 Strike plate entry only stainless steel

12.045.208 Levers only, pair U shape 142 mm long

12.222.208 Escutcheons, pair, inner and outer
245 x 45 x 7 mm

05.405.266 Keyway for 1 1/2" thick door
Keyway outside / thumb turn inside



Entry Lock Set #14.31U.208
Mirror Polished Stainless Steel

Dimensions:

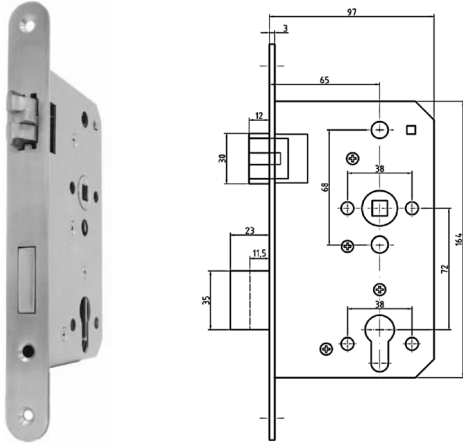

#14.3127.208 Entry Lock

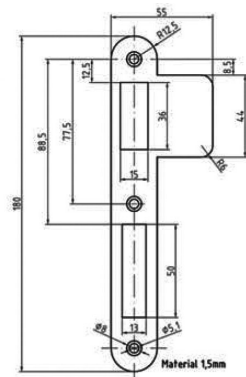
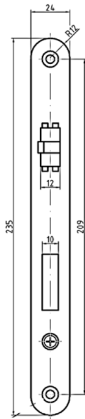

#14.0031.208 Strike Plate

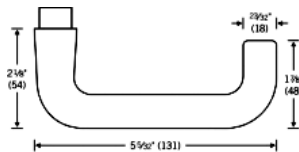

#12.045.208 U shaped Lever (pair)

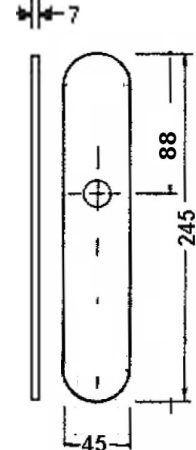

#12.222.208 Escutcheon Plates (pair) Invisible mounting

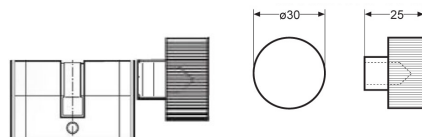

Profile Cylinder key/knob Series #05.405 for 1 1/2" thick doors

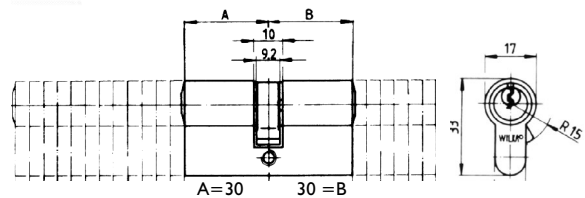

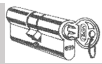

EUROPE TYPE HANDING

Standard European (DIN) Handing for Mortise Locks and Swinging Doors:

The DIN Standard (Deutsche Industrie Norm) applies to most Mega Yachts Door Schedules.

OUTSIDE

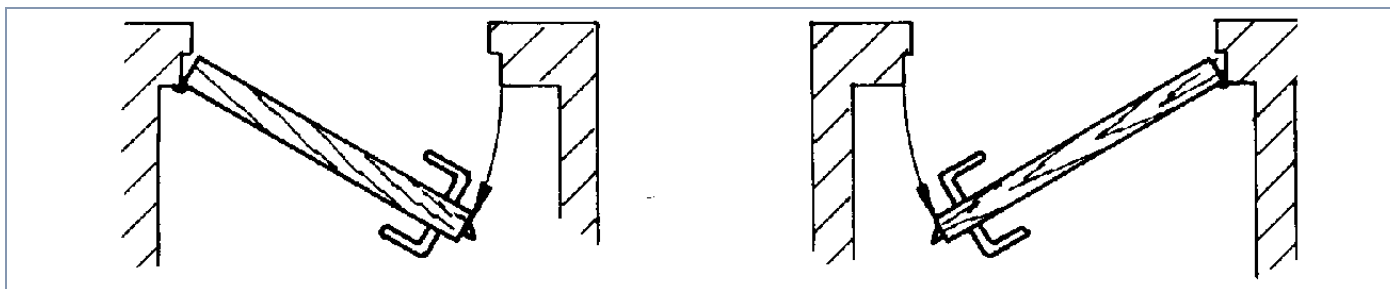

INSIDE

DIN LEFT HAND

DIN RIGHT HAND

STANDARD UNITED STATES Handing schedule:

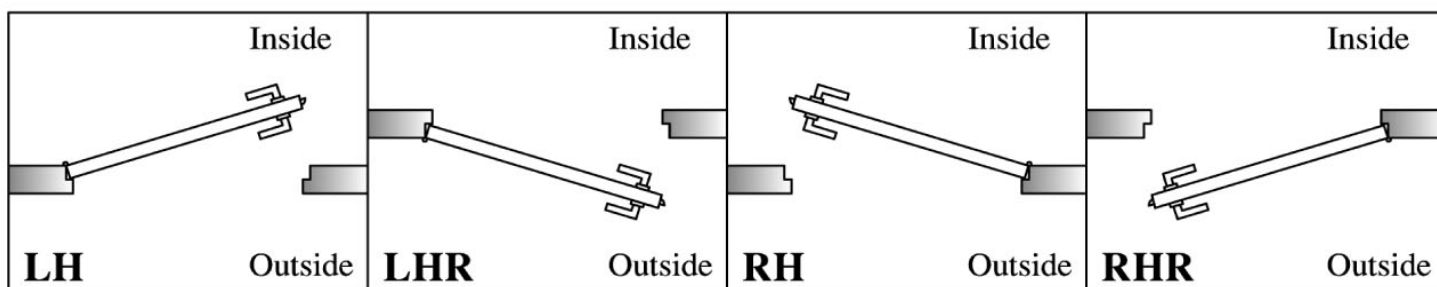

Handing Door Schedules for:

Residential European (DIN) and Residential American (US) Swinging Door
the following schedule applies, showing DIN Standard and US Standard:

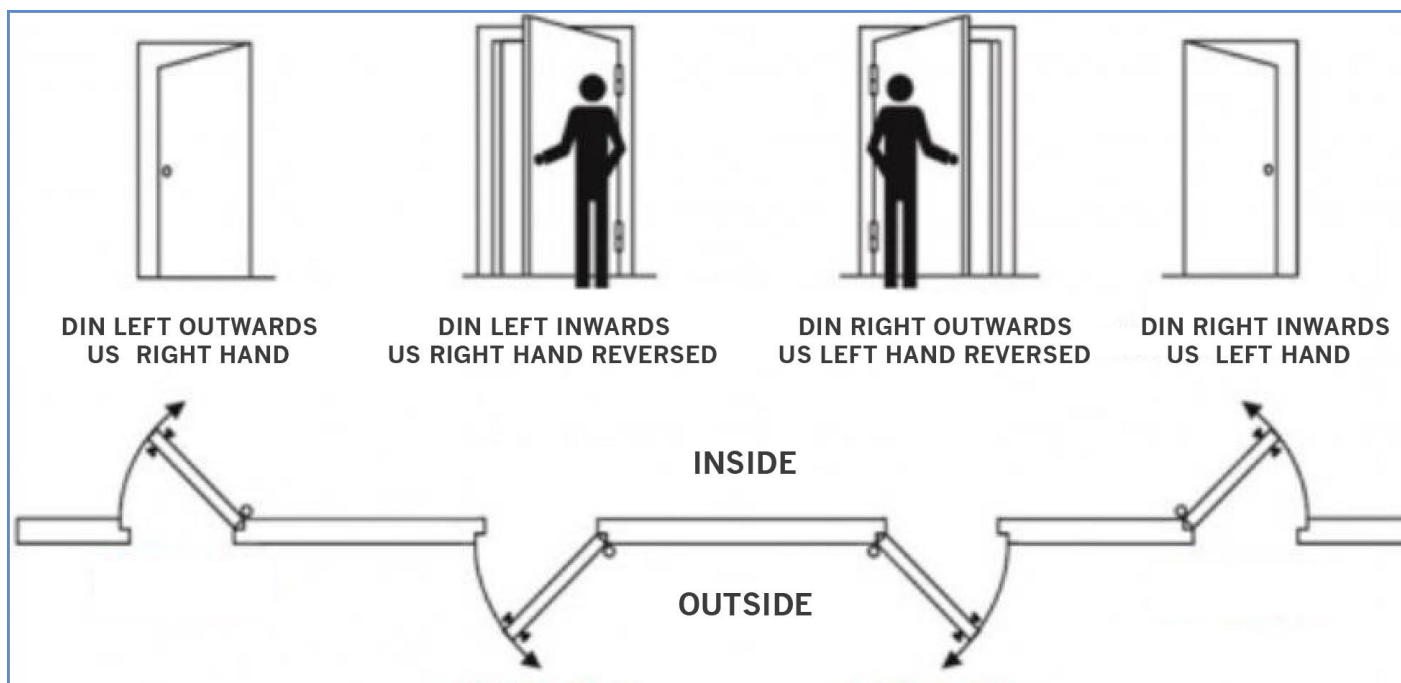



Minimum Door Installation Dimensions

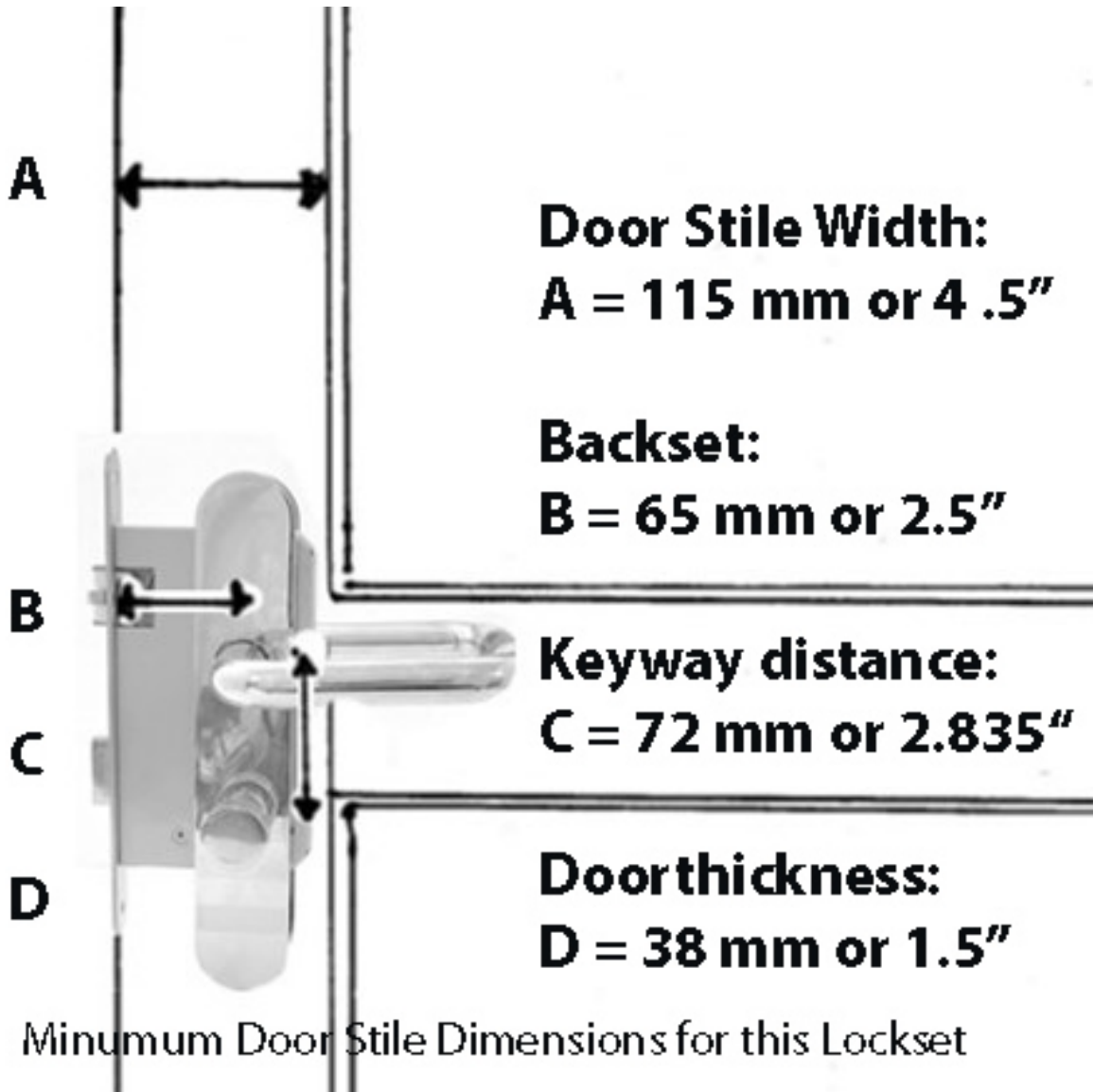



Entry Set #14.31U.208 Marine Grade



Entry Set #14.31U.208 Marine Grade